

MXL 025
PASSO 0,80" (2,032 mm)
PER CINGHIE LARGHEZZA 1/4" (6,35 mm)

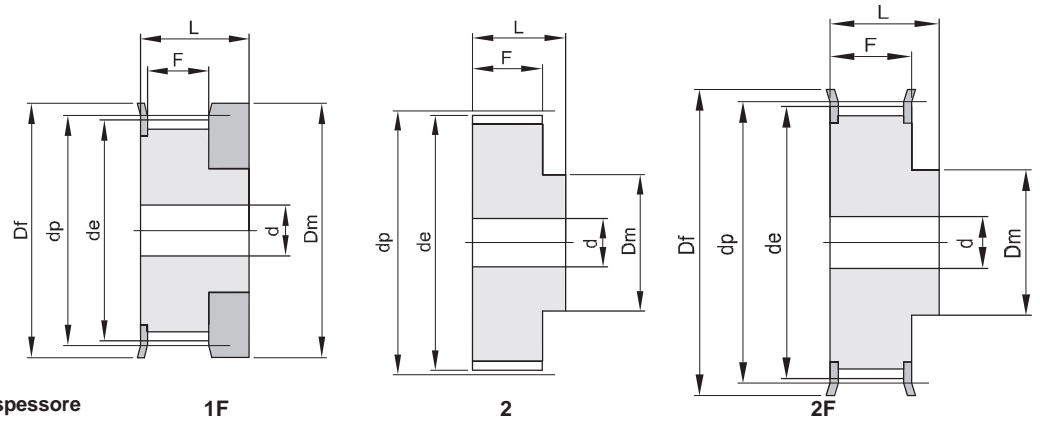

Material: Aluminio UNI 9006 - T6 (Al)
 adatto per l'ossidazione dura a spessore

codice	tipo	material	denti	dp	de	Df	Dm	F	L	d	n° flangia	Kg.
16 MXL 025	1F	Al	16	10,35	9,84	15	15	8,5	16		101	0,01
18 MXL 025	1F	Al	18	11,64	11,13	16	16	8,5	16		102	0,01
20 MXL 025	1F	Al	20	12,94	12,43	16	16	8,5	16		102	0,01
22 MXL 025	2F	Al	22	14,23	13,72	18	10	11	16	3	104	0,01
24 MXL 025	2F	Al	24	15,52	15,02	18	10	11	16	3	104	0,01
28 MXL 025	2F	Al	28	18,11	17,60	23	11	11	16	3	107	0,01
30 MXL 025	2F	Al	30	19,40	18,90	23	12	11	16	4	107	0,02
32 MXL 025	2F	Al	32	20,70	20,19	25	14	11	16	4	108	0,02
36 MXL 025	2F	Al	36	23,29	22,78	28	16	11	16	4	109	0,02
40 MXL 025	2F	Al	40	25,87	25,36	32	18	11	16	4	110	0,03
42 MXL 025	2F	Al	42	27,17	26,66	32	18	11	16	5	110	0,03
44 MXL 025	2F	Al	44	28,46	27,95	36	18	11	16	5	111	0,03
48 MXL 025	2	Al	48	31,05	30,54		20	11	16	5		0,03
60 MXL 025	2	Al	60	38,81	38,30		24	11	16	5		0,04
72 MXL 025	2	Al	72	46,57	46,06		25	11	16	6		0,05

XL 037

PASSO 1/5" (5,08 mm)

PER CINGHIE LARGHEZZA 3/8" (9,52 mm)

Material: Alluminio UNI 9006 - T6 (Al)
 adatto per l'ossidazione dura a spessore

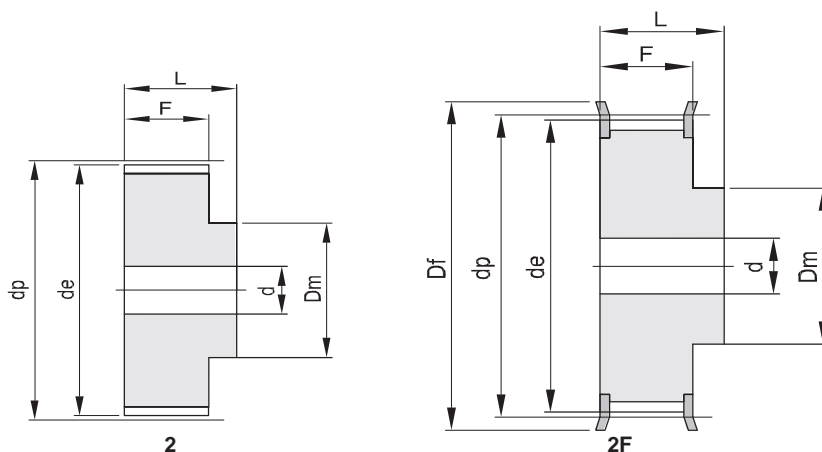

código	tipo	material	denti	dp	de	Df	Dm	F	L	d	nº flangia	Kg.
10 XL 037	2F	Al	10	16,17	15,66	23	10	14,3	20		201	0,01
11 XL 037	2F	Al	11	17,79	17,28	23	10	14,3	20		201	0,01
12 XL 037	2F	Al	12	19,40	18,9	25	10	14,3	20		203	0,01
13 XL 037	2F	Al	13	21,02	20,51	25	10	14,3	20		203	0,01
14 XL 037	2F	Al	14	22,64	23,13	28	16	14,3	20		204	0,02
15 XL 037	2F	Al	15	24,25	23,75	28	16	14,3	20		204	0,02
16 XL 037	2F	Al	16	25,87	25,36	32	16	14,3	20		205	0,03
17 XL 037	2F	Al	17	27,49	26,98	32	20	14,3	20		205	0,03
18 XL 037	2F	Al	18	29,11	28,60	36	20	14,3	20		206	0,04
19 XL 037	2F	Al	19	30,72	30,21	36	20	14,3	22		206	0,04
20 XL 037	2F	Al	20	32,34	31,83	38	25	14,3	22		207	0,05
21 XL 037	2F	Al	21	33,96	33,45	38	25	14,3	22		207	0,05
22 XL 037	2F	Al	22	35,57	35,07	42	25	14,3	22		208	0,06
24 XL 037	2F	Al	24	38,81	38,30	44	30	14,3	22		209	0,06
26 XL 037	2F	Al	26	42,04	41,53	48	30	14,3	22	8	210	0,09
27 XL 037	2F	Al	27	43,66	43,15	48	34	14,3	22	8	210	0,09
28 XL 037	2F	Al	28	45,28	44,77	51	34	14,3	22	8	211	0,10
30 XL 037	2F	Al	30	48,51	48,00	54	38	14,3	22	8	212	0,12
32 XL 037	2F	Al	32	51,74	51,24	57	38	14,3	25	8	213	0,12
34 XL 037	2F	Al	34	54,98	54,47	60	38	14,3	25	8	214	0,13
35 XL 037	2F	Al	35	56,60	56,09	63	38	14,3	25	8	215	0,14
36 XL 037	2	Al	36	58,21	57,70		45	14,3	25	8		0,14
38 XL 037	2	Al	38	61,45	60,94		45	14,3	25	8		0,15
40 XL 037	2	Al	40	64,68	64,17		45	14,3	25	8		0,16
42 XL 037	2	Al	42	67,91	67,41		45	14,3	25	8		0,18
44 XL 037	2	Al	44	71,15	70,64		45	14,3	25	8		0,19
48 XL 037	2	Al	48	77,62	77,11		45	14,3	25	10		0,19
52 XL 037	2	Al	52	84,08	83,57		45	14,3	25	10		0,19
60 XL 037	2	Al	60	97,02	96,51		45	14,3	25	10		0,22
72 XL 037	2	Al	72	116,42	115,92		45	14,3	25	10		0,44

POLEAS DENTADAS ESTÁNDAR ISO 5294 L

L 050

PASSO 3/8" (9,525 mm)

PER CINGHIE LARGHEZZA 1/2" (12,7 mm)

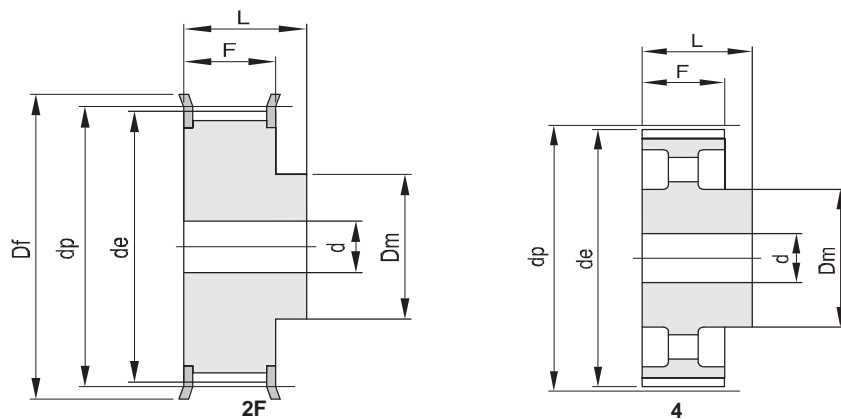

Material: Acciaio (St)
 Material: Ghisa (GG)

código	tipo	material	denti	dp	de	Df	Dm	F	L	d	n° flangia	Kg.
10 L 050	2F	St	10	30,32	29,56	36	20	19,0	28	8	300	0,11
11 L 050	2F	St	11	33,35	32,59	38	24	19,0	30	8	301	0,14
12 L 050	2F	St	12	36,38	35,62	42	24	19,0	30	8	302	0,17
13 L 050	2F	St	13	39,41	38,65	44	28	19,0	30	8	303	0,21
14 L 050	2F	St	14	42,44	41,68	48	28	19,0	30	8	304	0,24
15 L 050	2F	St	15	45,48	44,72	51	34	19,0	30	8	305	0,29
16 L 050	2F	St	16	48,51	47,75	54	36	19,0	32	8	306	0,33
17 L 050	2F	St	17	51,54	50,78	57	36	19,0	32	10	307	0,38
18 L 050	2F	St	18	54,57	53,81	60	40	19,0	32	10	308	0,44
19 L 050	2F	St	19	57,61	56,84	63	40	19,0	32	10	309	0,47
20 L 050	2F	St	20	60,64	59,88	66	40	19,0	32	10	310	0,51
21 L 050	2F	St	21	63,67	62,91	71	45	19,0	32	10	311	0,60
22 L 050	2F	St	22	66,70	65,94	75	45	19,0	32	10	312	0,64
23 L 050	2F	St	23	69,73	68,97	79	55	19,0	32	10	313	0,78
24 L 050	2F	St	24	72,77	72,00	79	55	19,0	32	10	313	0,81
25 L 050	2F	St	25	75,80	75,04	83	58	19,0	32	10	314	0,89
26 L 050	2F	St	26	78,83	78,07	87	58	19,0	32	12	315	0,94
27 L 050	2F	St	27	81,86	81,10	87	58	19,0	32	12	315	0,99
28 L 050	2F	St	28	84,89	84,13	91	58	19,0	32	12	316	1,04
30 L 050	2F	St	30	90,96	90,20	97	70	19,0	32	12	318	1,17
32 L 050	2F	St	32	97,03	96,26	103	70	19,0	32	12	320	1,41
33 L 050	2F	St	33	100,05	99,29	106	70	19,0	32	12	321	1,49
34 L 050	2F	St	34	103,08	102,32	111	70	19,0	32	12	322	1,57
35 L 050	2F	St	35	106,12	105,35	111	70	19,0	32	12	322	1,62
36 L 050	2F	St	36	109,15	108,39	115	70	19,0	32	12	323	1,70
40 L 050	2F	St	40	121,29	120,51	127	70	19,0	32	12	327	2,03
42 L 050	2F	St	42	127,34	126,58	135	70	19,0	32	12	328	2,21
44 L 050	2F	St	44	133,40	132,64	140	70	19,0	32	12	330	2,38
45 L 050	2F	St	45	136,44	135,67	143	70	19,0	32	12	331	2,48
48 L 050	2F	St	48	145,53	144,77	152	70	19,0	32	12	334	2,78
50 L 050	4	GG	50	151,60	150,83		70	19,0	32	14		1,74
52 L 050	4	GG	52	157,66	156,90		70	19,0	32	14		1,80
56 L 050	4	GG	56	169,79	169,02		70	19,0	32	14		1,87
57 L 050	4	GG	57	172,82	172,06		70	19,0	32	14		1,88
60 L 050	4	GG	60	181,91	181,15		75	19,0	42	14		2,41
72 L 050	4	GG	72	218,29	217,53		75	19,0	42	14		2,82
84 L 050	4	GG	84	254,68	253,92		75	19,0	42	14		3,08
96 L 050	4	GG	96	291,06	290,30		75	19,0	42	14		3,42

POLEAS DENTADAS ESTÁNDAR ISO 5294 L

L 075

PASSO 3/8" (9,525 mm)

PER CINGHIE LARGHEZZA 3/4" (19,05 mm)

Material: Acciaio (St)
 Material: Ghisa (GG)

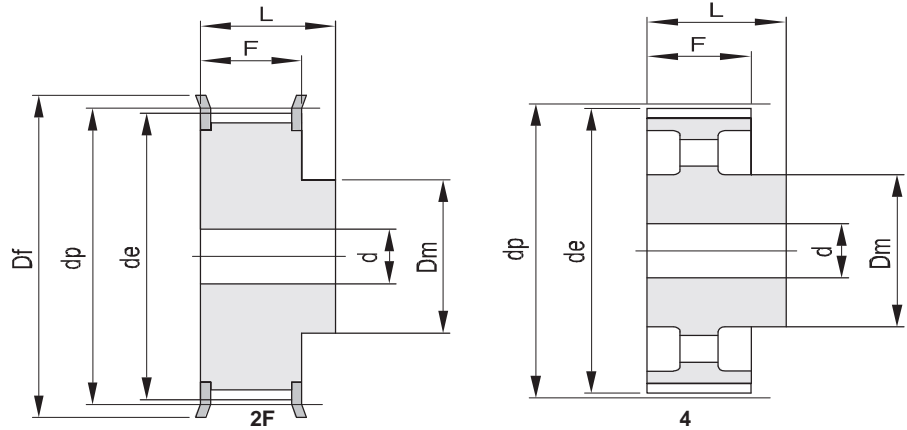

código	tipo	material	denti	dp	de	Df	Dm	F	L	d	n° flangia	Kg.
10 L 075	2F	St	10	30,32	29,56	36	20	25,4	38	8	300	0,14
11 L 075	2F	St	11	33,35	32,59	38	24	25,4	38	8	301	0,18
12 L 075	2F	St	12	36,38	35,62	42	24	25,4	38	8	302	0,22
13 L 075	2F	St	13	39,41	38,65	44	28	25,4	38	8	303	0,26
14 L 075	2F	St	14	42,44	41,68	48	28	25,4	38	8	304	0,30
15 L 075	2F	St	15	45,48	44,72	51	34	25,4	38	8	305	0,37
16 L 075	2F	St	16	48,51	47,75	54	36	25,4	38	8	306	0,43
17 L 075	2F	St	17	51,54	50,78	57	36	25,4	38	10	307	0,46
18 L 075	2F	St	18	54,57	53,81	60	40	25,4	38	10	308	0,54
19 L 075	2F	St	19	57,61	56,84	63	40	25,4	38	10	309	0,58
20 L 075	2F	St	20	60,64	59,88	66	40	25,4	38	10	310	0,64
21 L 075	2F	St	21	63,67	62,91	71	45	25,4	38	10	311	0,71
22 L 075	2F	St	22	66,70	65,94	75	45	25,4	38	10	312	0,79
23 L 075	2F	St	23	69,73	68,97	79	55	25,4	38	10	313	0,94
24 L 075	2F	St	24	72,77	72,00	79	55	25,4	38	10	313	1,00
25 L 075	2F	St	25	75,80	75,04	83	58	25,4	38	10	314	1,10
26 L 075	2F	St	26	78,83	78,07	87	58	25,4	38	12	315	1,16
27 L 075	2F	St	27	81,86	81,10	87	58	25,4	38	12	315	1,22
28 L 075	2F	St	28	84,89	84,13	91	58	25,4	38	12	316	1,30
30 L 075	2F	St	30	90,96	90,20	97	70	25,4	38	12	318	1,47
32 L 075	2F	St	32	97,03	96,26	103	70	25,4	38	12	320	1,75
33 L 075	2F	St	33	100,05	99,29	106	70	25,4	38	12	321	1,85
34 L 075	2F	St	34	103,08	102,32	111	70	25,4	38	12	322	1,93
35 L 075	2F	St	35	106,12	105,35	111	70	25,4	38	12	322	2,03
36 L 075	2F	St	36	109,15	108,39	115	70	25,4	38	12	323	2,14
40 L 075	2F	St	40	121,29	120,51	127	70	25,4	38	12	327	2,56
42 L 075	2F	St	42	127,34	126,58	135	70	25,4	38	12	328	2,81
44 L 075	2F	St	44	133,40	132,64	140	70	25,4	38	12	330	3,02
45 L 075	2F	St	45	136,44	135,67	143	70	25,4	38	12	331	3,16
48 L 075	2F	St	48	145,53	144,77	152	70	25,4	38	12	334	3,57
50 L 075	4	GG	50	151,60	150,83		70	25,4	38	14		2,10
52 L 075	4	GG	52	157,66	156,90		70	25,4	38	14		2,13
56 L 075	4	GG	56	169,79	169,02		70	25,4	38	14		2,27
57 L 075	4	GG	57	172,82	172,06		70	25,4	38	14		2,28
60 L 075	4	GG	60	181,91	181,15		75	25,4	45	14		2,70
72 L 075	4	GG	72	218,29	217,53		75	25,4	45	14		3,19
84 L 075	4	GG	84	254,68	253,92		75	25,4	45	14		3,64
96 L 075	4	GG	96	291,06	290,30		75	25,4	45	14		4,04

POLEAS DENTADAS ESTÁNDAR ISO 5294 L

L 100

PASSO 3/8" (9,525 mm)

PER CINGHIE LARGHEZZA 1" (25,4 mm)

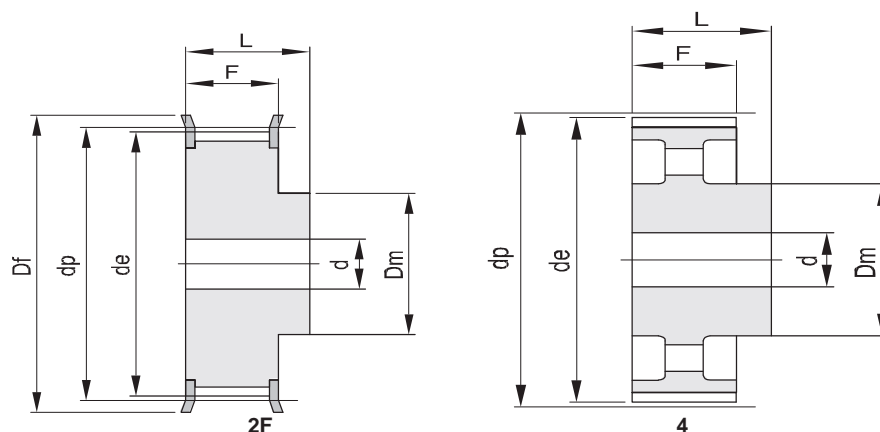

Material: Acciaio (St)
 Material: Ghisa (GG)

código	tipo	material	denti	dp	de	Df	Dm	F	L	d	n° flangia	Kg.
10 L 100	2F	St	10	30,32	29,56	36	20	31,8	45	8	300	0,17
11 L 100	2F	St	11	33,35	32,59	38	24	31,8	45	8	301	0,22
12 L 100	2F	St	12	36,38	35,62	42	24	31,8	45	8	302	0,26
13 L 100	2F	St	13	39,41	38,65	44	28	31,8	45	8	303	0,32
14 L 100	2F	St	14	42,44	41,68	48	28	31,8	45	10	304	0,35
15 L 100	2F	St	15	45,48	44,72	51	34	31,8	45	10	305	0,43
16 L 100	2F	St	16	48,51	47,75	54	36	31,8	45	10	306	0,50
17 L 100	2F	St	17	51,54	50,78	57	36	31,8	45	10	307	0,56
18 L 100	2F	St	18	54,57	53,81	60	40	31,8	45	10	308	0,64
19 L 100	2F	St	19	57,61	56,84	63	40	31,8	45	10	309	0,70
20 L 100	2F	St	20	60,64	59,88	66	40	31,8	45	10	310	0,77
21 L 100	2F	St	21	63,67	62,91	71	45	31,8	45	10	311	0,88
22 L 100	2F	St	22	66,70	65,94	75	45	31,8	45	12	312	0,95
23 L 100	2F	St	23	69,73	68,97	79	55	31,8	45	12	313	1,11
24 L 100	2F	St	24	72,77	72,00	79	55	31,8	45	12	313	1,18
25 L 100	2F	St	25	75,80	75,04	83	58	31,8	45	12	314	1,30
26 L 100	2F	St	26	78,83	78,07	87	58	31,8	45	12	315	1,40
27 L 100	2F	St	27	81,86	81,10	87	58	31,8	45	12	315	1,47
28 L 100	2F	St	28	84,89	84,13	91	58	31,8	45	12	316	1,58
30 L 100	2F	St	30	90,96	90,20	97	70	31,8	45	12	318	1,78
32 L 100	2F	St	32	97,03	96,26	103	70	31,8	45	12	320	2,11
33 L 100	2F	St	33	100,05	99,29	106	70	31,8	45	12	321	2,23
34 L 100	2F	St	34	103,08	102,32	111	70	31,8	45	12	322	2,39
35 L 100	2F	St	35	106,12	105,35	111	70	31,8	45	12	322	2,45
36 L 100	2F	St	36	109,15	108,39	115	70	31,8	45	12	323	2,59
40 L 100	2F	St	40	121,29	120,51	127	70	31,8	45	12	327	3,13
42 L 100	2F	St	42	127,34	126,58	135	70	31,8	45	12	328	3,43
44 L 100	2F	St	44	133,40	132,64	140	70	31,8	45	12	330	3,72
45 L 100	2F	St	45	136,44	135,67	143	70	31,8	45	12	331	3,89
48 L 100	2F	St	48	145,53	144,77	152	70	31,8	45	12	334	4,38
50 L 100	4	GG	50	151,60	150,83		70	31,8	45	14		2,41
52 L 100	4	GG	52	157,66	156,90		70	31,8	45	14		2,55
56 L 100	4	GG	56	169,79	169,02		70	31,8	45	14		2,65
57 L 100	4	GG	57	172,82	172,06		70	31,8	45	14		2,71
60 L 100	4	GG	60	181,91	181,15		75	31,8	45	14		3,11
72 L 100	4	GG	72	218,29	217,53		75	31,8	45	14		3,65
84 L 100	4	GG	84	254,68	253,92		75	31,8	45	14		4,12
96 L 100	4	GG	96	291,06	290,30		75	31,8	45	14		4,60

POLEAS DENTADAS ESTÁNDAR ISO 5294 H

H 075

PASSO 1/2" (12,7 mm)

PER CINGHIE LARGHEZZA 3/4" (19,05 mm)

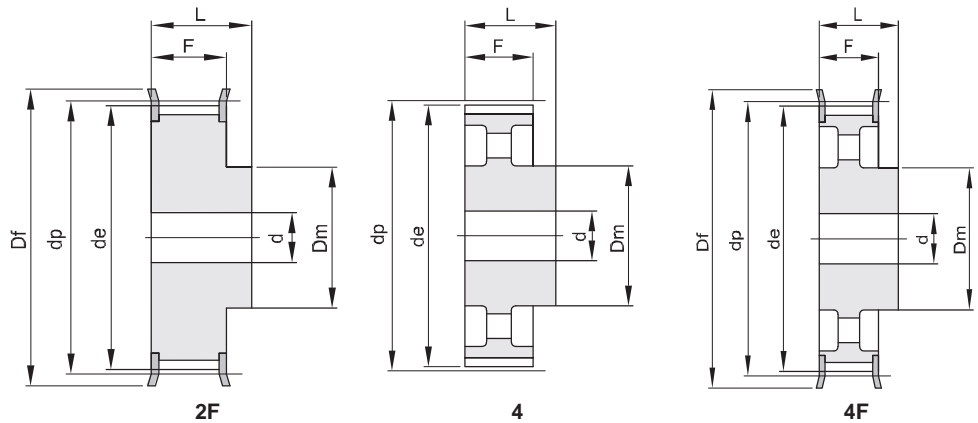

Material: Acciaio (St)
 Material: Ghisa (GG)

código	tipo	material	denti	dp	de	Df	Dm	F	L	d	n° flangia	Kg.
14 H 075	2F	St	14	56,59	55,22	63	40	26,4	40	10	309	0,58
15 H 075	2F	St	15	60,64	59,27	66	45	26,4	40	10	310	0,69
16 H 075	2F	St	16	64,68	63,31	71	45	26,4	40	10	311	0,77
17 H 075	2F	St	17	68,72	67,35	75	45	26,4	40	12	312	0,84
18 H 075	2F	St	18	72,77	71,39	79	55	26,4	40	12	313	1,01
19 H 075	2F	St	19	76,81	75,44	83	60	26,4	40	12	314	1,15
20 H 075	2F	St	20	80,85	79,48	87	62	26,4	40	12	315	1,27
21 H 075	2F	St	21	84,89	83,52	91	65	26,4	40	12	316	1,41
22 H 075	2F	St	22	88,94	87,56	93	68	26,4	40	12	317	1,55
23 H 075	2F	St	23	92,98	91,61	97	72	26,4	40	12	318	1,71
24 H 075	2F	St	24	97,03	95,65	103	72	26,4	40	12	320	1,83
25 H 075	2F	St	25	101,06	99,69	106	72	26,4	40	12	321	1,96
26 H 075	2F	St	26	105,11	103,73	111	80	26,4	40	12	322	2,19
27 H 075	2F	St	27	109,15	107,78	115	80	26,4	40	12	323	2,32
28 H 075	2F	St	28	113,19	111,82	119	80	26,4	40	12	325	2,47
30 H 075	2F	St	30	121,29	119,90	127	80	26,4	40	14	327	2,76
32 H 075	2F	St	32	129,36	127,99	135	80	26,4	40	14	328	3,08
33 H 075	2F	St	33	133,40	132,03	140	80	26,4	40	14	330	3,25
34 H 075	2F	St	34	137,45	136,07	143	80	26,4	40	14	331	3,42
35 H 075	2F	St	35	141,49	140,12	148	80	26,4	40	14	333	3,61
36 H 075	2F	St	36	145,53	144,16	152	80	26,4	40	14	334	3,79
38 H 075	2F	St	38	153,62	152,24	158	80	26,4	40	14	335	4,16
40 H 075	2F	St	40	161,70	160,33	168	80	26,4	40	14	338	4,58
44 H 075	4F	GG	44	177,87	176,50	184	80	26,4	40	18	339	2,57
48 H 075	4F	GG	48	194,04	192,67	200	90	26,4	45	18	342	3,56
50 H 075	4	GG	50	202,13	200,75	90	26,4	45	18	18		3,74

POLEAS DENTADAS ESTÁNDAR ISO 5294 H

H 100

PASSO 1/2" (12,7 mm)

PER CINGHIE LARGHEZZA 1" (25,4 mm)

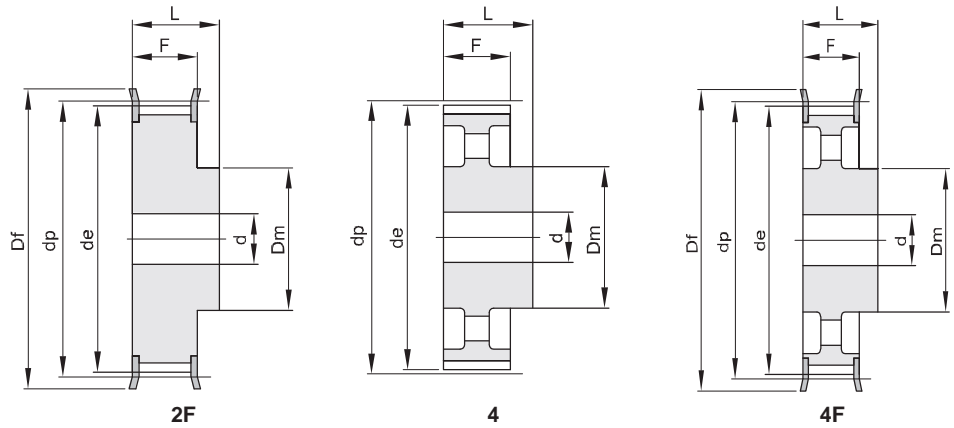

Material: Acciaio (St)
Material: Ghisa (GG)

código	tipo	material	denti	dp	de	Df	Dm	F	L	d	n° flangia	Kg.
14 H 100	2F	St	14	56,59	55,22	63	40	31,8	45	12	309	0,65
15 H 100	2F	St	15	60,64	59,27	66	45	31,8	45	12	310	0,77
16 H 100	2F	St	16	64,68	63,31	71	45	31,8	45	12	311	0,87
17 H 100	2F	St	17	68,72	67,35	75	45	31,8	45	12	312	0,97
18 H 100	2F	St	18	72,77	71,39	79	55	31,8	45	12	313	1,16
19 H 100	2F	St	19	76,81	75,44	83	60	31,8	45	14	314	1,30
20 H 100	2F	St	20	80,85	79,48	87	62	31,8	45	14	315	1,44
21 H 100	2F	St	21	84,89	83,52	91	65	31,8	45	14	316	1,60
22 H 100	2F	St	22	88,94	87,56	93	68	31,8	45	14	317	1,76
23 H 100	2F	St	23	92,98	91,61	97	72	31,8	45	14	318	1,94
24 H 100	2F	St	24	97,03	95,65	103	72	31,8	45	14	320	2,09
25 H 100	2F	St	25	101,06	99,69	106	72	31,8	45	14	321	2,24
26 H 100	2F	St	26	105,11	103,73	111	80	31,8	45	14	322	2,49
27 H 100	2F	St	27	109,15	107,78	115	80	31,8	45	14	323	2,66
28 H 100	2F	St	28	113,19	111,82	119	80	31,8	45	14	325	2,83
29 H 100	2F	St	29	117,23	115,86	123	80	31,8	45	14	326	3,01
30 H 100	2F	St	30	121,29	119,90	127	80	31,8	45	14	327	3,19
32 H 100	2F	St	32	129,36	127,99	135	80	31,8	45	14	328	3,57
33 H 100	2F	St	33	133,40	132,03	140	80	31,8	45	14	330	3,79
34 H 100	2F	St	34	137,45	136,07	143	80	31,8	45	14	331	3,99
35 H 100	2F	St	35	141,49	140,12	148	80	31,8	45	14	333	4,20
36 H 100	2F	St	36	145,53	144,16	152	80	31,8	45	14	334	4,44
38 H 100	2F	St	38	153,62	152,24	158	80	31,8	45	14	335	4,90
40 H 100	2F	St	40	161,70	160,33	168	80	31,8	45	14	338	5,39
44 H 100	4F	GG	44	177,87	176,50	184	80	31,8	50	18	339	3,37
45 H 100	4F	GG	45	181,91	180,54	192	80	31,8	50	18	340	3,57
48 H 100	4F	GG	48	194,04	192,67	200	90	31,8	50	18	342	4,10
50 H 100	4	GG	50	202,13	200,75		90	31,8	50	18		4,24
52 H 100	4	GG	52	210,21	208,84		90	31,8	50	18		4,32
58 H 100	4	GG	58	234,47	233,09		90	31,8	50	18		4,61
60 H 100	4	GG	60	242,55	241,18		100	31,8	50	18		5,30
70 H 100	4	GG	70	282,98	281,61		100	31,8	55	18		6,13
72 H 100	4	GG	72	291,06	289,69		120	31,8	55	18		7,47
84 H 100	4	GG	84	339,57	338,20		120	31,8	55	18		8,52
96 H 100	4	GG	96	388,08	386,71		120	31,8	60	18		10,25
120 H 100	4	GG	120	485,10	483,73		120	31,8	60	18		13,09

POLEAS DENTADAS ESTÁNDAR ISO 5294 H

H 150

PASSO 1/2" (12,7 mm)

PER CINGHIE LARGHEZZA 1 1/2 (38,1 mm)

Material: Acciaio (St)
 Material: Ghisa (GG)

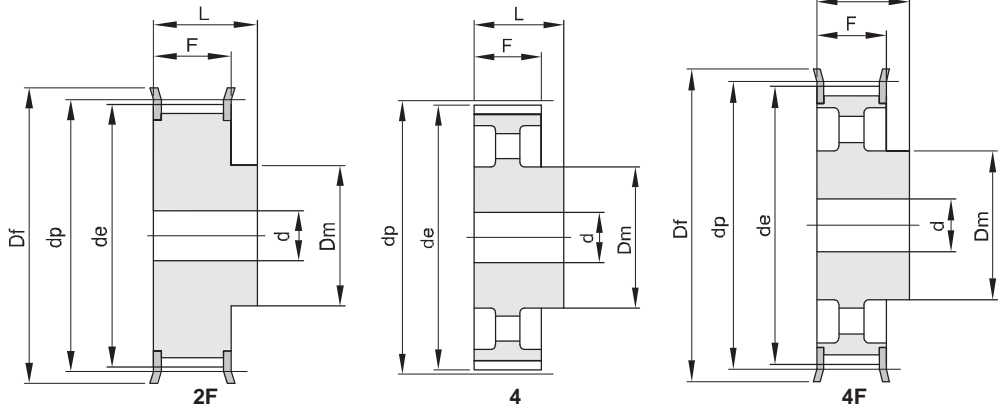

código	tipo	material	denti	dp	de	Df	Dm	F	L	d	n° flangia	Kg.
14 H 150	2F	St	14	56,59	55,22	63	40	46,0	58	18	309	0,81
15 H 150	2F	St	15	60,64	59,27	66	45	46,0	58	18	310	0,97
16 H 150	2F	St	16	64,68	63,31	71	45	46,0	58	18	311	1,11
17 H 150	2F	St	17	68,72	67,35	75	45	46,0	58	18	312	1,25
18 H 150	2F	St	18	72,77	71,39	79	55	46,0	58	18	313	1,48
19 H 150	2F	St	19	76,81	75,44	83	60	46,0	58	18	314	1,68
20 H 150	2F	St	20	80,85	79,48	87	62	46,0	58	18	315	1,88
21 H 150	2F	St	21	84,89	83,52	91	65	46,0	58	18	316	2,08
22 H 150	2F	St	22	88,94	87,56	93	68	46,0	58	18	317	2,30
23 H 150	2F	St	23	92,98	91,61	97	72	46,0	58	18	318	2,54
24 H 150	2F	St	24	97,03	95,65	103	72	46,0	58	18	320	2,75
25 H 150	2F	St	25	101,06	99,69	106	72	46,0	58	18	321	2,97
26 H 150	2F	St	26	105,11	103,73	111	80	46,0	58	18	322	3,29
27 H 150	2F	St	27	109,15	107,78	115	80	46,0	58	18	323	3,52
28 H 150	2F	St	28	113,19	111,82	119	80	46,0	58	18	325	3,78
29 H 150	2F	St	29	117,23	115,86	123	80	46,0	58	18	326	4,03
30 H 150	2F	St	30	121,29	119,90	127	80	46,0	58	18	327	4,29
32 H 150	2F	St	32	129,36	127,99	135	80	46,0	58	18	328	4,86
33 H 150	2F	St	33	133,40	132,03	140	80	46,0	58	18	330	5,15
34 H 150	2F	St	34	137,45	136,07	143	80	46,0	58	18	331	5,46
35 H 150	2F	St	35	141,49	140,12	148	80	46,0	58	18	333	5,78
36 H 150	2F	St	36	145,53	144,16	152	80	46,0	58	18	334	6,09
38 H 150	2F	St	38	153,62	152,24	158	80	46,0	58	18	335	6,74
40 H 150	2F	St	40	161,70	160,33	168	80	46,0	58	18	338	7,46
44 H 150	4F	GG	44	177,87	176,50	184	80	46,0	58	18	339	4,29
45 H 150	4F	GG	45	181,91	180,54	192	80	46,0	58	18	340	4,44
48 H 150	4F	GG	48	194,04	192,67	200	90	46,0	65	18	342	5,41
50 H 150	4	GG	50	202,13	200,75		90	46,0	65	18		5,59
52 H 150	4	GG	52	210,21	208,84		90	46,0	65	18		5,79
58 H 150	4	GG	58	234,47	233,09		90	46,0	65	18		6,15
60 H 150	4	GG	60	242,55	241,18		100	46,0	65	18		7,08
70 H 150	4	GG	70	282,98	281,61		100	46,0	65	24		7,77
72 H 150	4	GG	72	291,06	289,69		120	46,0	65	24		9,70
84 H 150	4	GG	84	339,57	338,20		120	46,0	65	24		10,99
96 H 150	4	GG	96	388,08	386,71		120	46,0	65	24		12,24
120 H 150	4	GG	120	485,10	483,73		120	46,0	65	24		16,17

POLEAS DENTADAS ESTÁNDAR ISO 5294 H

H 200

PASSO 1/2" (12,7 mm)

PER CINGHIE LARGHEZZA 2" (50,8 mm)

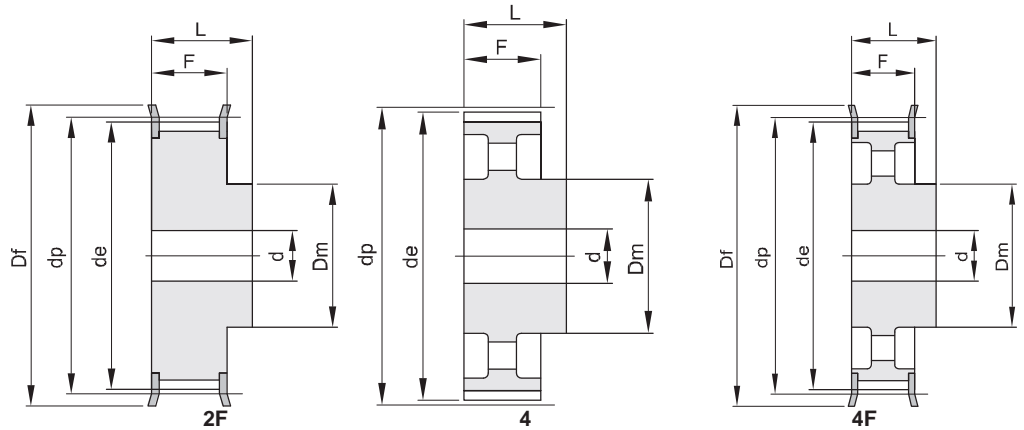

Material: Acciaio (St)
 Material: Ghisa (GG)

código	tipo	material	denti	dp	de	Df	Dm	F	L	d	n° flangia	Kg.
14 H 200	2F	St	14	56,59	55,22	63	40	58,7	70	18	309	1,10
15 H 200	2F	St	15	60,64	59,27	66	45	58,7	70	18	310	1,33
16 H 200	2F	St	16	64,68	63,31	71	45	58,7	70	18	311	1,54
17 H 200	2F	St	17	68,72	67,35	75	45	58,7	70	18	312	1,69
18 H 200	2F	St	18	72,77	71,39	79	55	58,7	70	18	313	1,95
19 H 200	2F	St	19	76,81	75,44	83	60	58,7	70	18	314	2,20
20 H 200	2F	St	20	80,85	79,48	87	62	58,7	70	18	315	2,44
21 H 200	2F	St	21	84,89	83,52	91	65	58,7	70	18	316	2,70
22 H 200	2F	St	22	88,94	87,56	93	68	58,7	70	18	317	2,97
23 H 200	2F	St	23	92,98	91,61	97	72	58,7	70	18	318	3,25
24 H 200	2F	St	24	97,03	95,65	103	72	58,7	70	18	320	3,56
25 H 200	2F	St	25	101,06	99,69	106	72	58,7	70	18	321	3,81
26 H 200	2F	St	26	105,11	103,73	111	80	58,7	70	18	322	4,18
27 H 200	2F	St	27	109,15	107,78	115	80	58,7	70	18	323	4,49
28 H 200	2F	St	28	113,19	111,82	119	80	58,7	70	18	325	4,81
29 H 200	2F	St	29	117,23	115,86	123	80	58,7	70	18	326	5,14
30 H 200	2F	St	30	121,29	119,90	127	80	58,7	70	18	327	5,47
32 H 200	2F	St	32	129,36	127,99	135	80	58,7	70	18	328	6,17
33 H 200	2F	St	33	133,40	132,03	140	80	58,7	70	18	330	6,56
34 H 200	2F	St	34	137,45	136,07	143	80	58,7	70	18	331	6,94
35 H 200	2F	St	35	141,49	140,12	148	80	58,7	70	18	333	7,34
36 H 200	2F	St	36	145,53	144,16	152	80	58,7	70	18	334	7,75
38 H 200	2F	St	38	153,62	152,24	158	80	58,7	70	18	335	8,62
40 H 200	2F	St	40	161,70	160,33	168	80	58,7	70	18	338	9,50
44 H 200	4F	GG	44	177,87	176,50	184	80	58,7	70	18	339	5,14
45 H 200	4F	GG	45	181,91	180,54	192	80	58,7	70	18	340	5,38
48 H 200	4F	GG	48	194,04	192,67	200	90	58,7	75	24	342	6,29
50 H 200	4	GG	50	202,13	200,75		90	58,7	75	24		6,68
52 H 200	4	GG	52	210,21	208,84		90	58,7	75	24		6,81
58 H 200	4	GG	58	234,47	233,09		90	58,7	75	24		7,26
60 H 200	4	GG	60	242,55	241,18		100	58,7	75	24		8,25
70 H 200	4	GG	70	282,98	281,61		100	58,7	75	28		9,20
72 H 200	4	GG	72	291,06	289,69		120	58,7	75	28		11,09
84 H 200	4	GG	84	339,57	338,20		120	58,7	75	28		12,63
96 H 200	4	GG	96	388,08	386,71		120	58,7	75	28		14,51
120 H 200	4	GG	120	485,10	483,73		120	58,7	75	28		19,15

POLEAS DENTADAS ESTÁNDAR ISO 5294 H

H 300
PASSO 1/2" (12,7 mm)
PER CINGHIE LARGHEZZA 3" (76,2 mm)

Material: Acciaio (St)
 Material: Ghisa (GG)

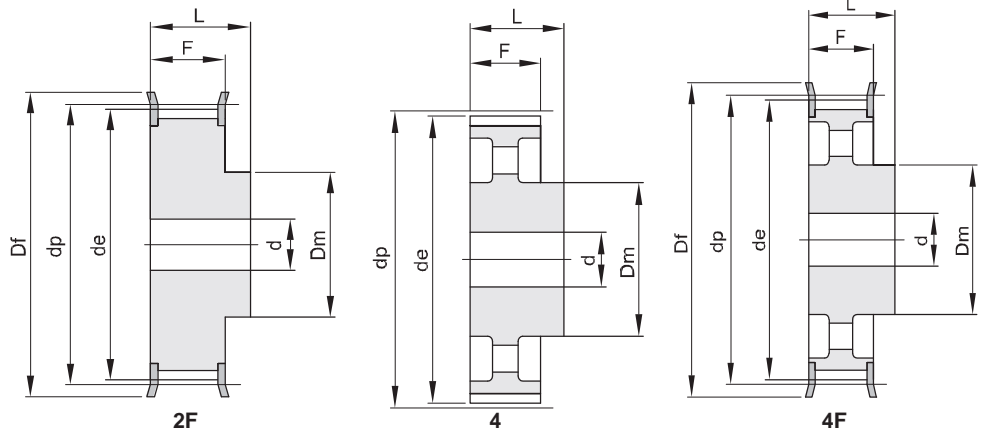

código	tipo	material	denti	dp	de	Df	Dm	F	L	d	n° flangia	Kg.
14 H 300	2F	St	14	56,59	55,22	63	40	85,7	100	18	309	1,64
15 H 300	2F	St	15	60,64	59,27	66	45	85,7	100	18	310	1,91
16 H 300	2F	St	16	64,68	63,31	71	45	85,7	100	18	311	2,16
17 H 300	2F	St	17	68,72	67,35	75	45	85,7	100	18	312	2,43
18 H 300	2F	St	18	72,77	71,39	79	55	85,7	100	18	313	2,80
19 H 300	2F	St	19	76,81	75,44	83	60	85,7	100	18	314	3,16
20 H 300	2F	St	20	80,85	79,48	87	62	85,7	100	18	315	3,50
21 H 300	2F	St	21	84,89	83,52	91	65	85,7	100	18	316	3,87
22 H 300	2F	St	22	88,94	87,56	93	68	85,7	100	18	317	4,26
23 H 300	2F	St	23	92,98	91,61	97	72	85,7	100	18	318	4,68
24 H 300	2F	St	24	97,03	95,65	103	72	85,7	100	18	320	5,08
25 H 300	2F	St	25	101,06	99,69	106	72	85,7	100	18	321	5,45
26 H 300	2F	St	26	105,11	103,73	111	80	85,7	100	18	322	6,01
27 H 300	2F	St	27	109,15	107,78	115	80	85,7	100	18	323	6,45
28 H 300	2F	St	28	113,19	111,82	119	80	85,7	100	18	325	6,91
30 H 300	2F	St	30	121,29	119,90	127	80	85,7	100	18	327	7,90
32 H 300	2F	St	32	129,36	127,99	135	80	85,7	100	18	328	8,92
33 H 300	2F	St	33	133,40	132,03	140	80	85,7	100	18	330	9,46
34 H 300	2F	St	34	137,45	136,07	143	80	85,7	100	18	331	10,04
35 H 300	2F	St	35	141,49	140,12	148	80	85,7	100	18	333	10,62
36 H 300	2F	St	36	145,53	144,16	152	80	85,7	100	18	334	11,24
38 H 300	2F	St	38	153,62	152,24	158	80	85,7	100	18	335	12,44
40 H 300	2F	St	40	161,70	160,33	168	80	85,7	100	18	338	13,80
44 H 300	4F	GG	44	177,87	176,50	184	80	85,7	100	24	339	7,22
48 H 300	4F	GG	48	194,04	192,67	200	90	85,7	100	24	342	8,60
50 H 300	4	GG	50	202,13	200,75		90	85,7	100	24		8,99
58 H 300	4	GG	58	234,47	233,09		90	85,7	100	24		10,04
60 H 300	4	GG	60	242,55	241,18		100	85,7	100	24		11,18
72 H 300	4	GG	72	291,06	289,69		120	85,7	100	28		15,07
84 H 300	4	GG	84	339,57	338,20		120	85,7	100	28		16,97
96 H 300	4	GG	96	388,08	386,71		120	85,7	100	28		19,86
120 H 300	4	GG	120	485,10	483,73		120	85,7	100	28		25,91

POLEAS DENTADAS ESTÁNDAR ISO 5294 XH

XH 200

PASSO 7/8" (22,22 mm)

PER CINGHIE LARGHEZZA 2" (50,8 mm)

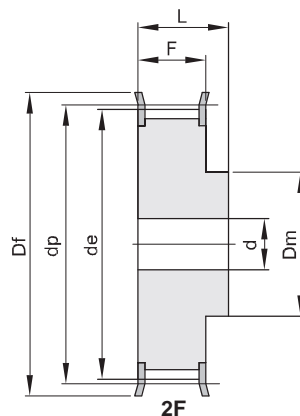

Material: Acciaio (St)

código	tipo	material	denti	dp	de	Df	Dm	F	L	d	n° flangia	Kg.
18 XH 200	2F	St	18	127,34	124,55	138	100	65	80	24	401	6,00
19 XH 200	2F	St	19	134,41	131,62	146	100	65	80	24	402	6,60
20 XH 200	2F	St	20	141,49	138,69	154	100	65	80	24	403	7,30
21 XH 200	2F	St	21	148,56	145,77	160	110	65	80	24	404	8,73
22 XH 200	2F	St	22	155,64	152,84	168	110	65	80	24	405	9,55
24 XH 200	2F	St	24	169,79	166,99	183	120	65	80	24	406	11,47
25 XH 200	2F	St	25	176,86	174,07	188	120	65	80	24	407	12,46
26 XH 200	2F	St	26	183,93	181,14	198	120	65	80	24	409	13,47
27 XH 200	2F	St	27	191,01	188,22	200	120	65	80	24	410	14,42
28 XH 200	2F	St	28	198,09	195,29	211	120	65	80	24	411	15,44
30 XH 200	2F	St	30	212,23	209,44	226	120	65	80	24	412	17,69
32 XH 200	2F	St	32	226,38	223,59	240	120	65	80	24	414	19,95
34 XH 200	2F	St	34	240,53	237,74	256	120	65	80	24	415	22,75

XH 300

PASSO 7/8" (22,22 mm)

PER CINGHIE LARGHEZZA 3" (76,2 mm)

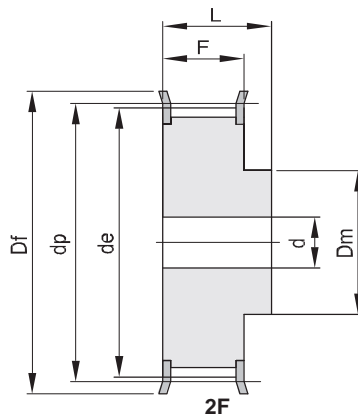

Material: Acciaio (St)

código	tipo	material	denti	dp	de	Df	Dm	F	L	d	n° flangia	Kg.
18 XH 300	2F	St	18	127,34	124,55	138	100	92	110	28	401	8,90
19 XH 300	2F	St	19	134,41	131,62	146	100	92	110	28	402	9,20
20 XH 300	2F	St	20	141,49	138,69	154	100	92	110	28	403	10,61
21 XH 300	2F	St	21	148,56	145,77	160	110	92	110	28	404	11,87
22 XH 300	2F	St	22	155,64	152,84	168	110	92	110	28	405	13,08
24 XH 300	2F	St	24	169,79	166,99	183	120	92	110	28	406	15,77
25 XH 300	2F	St	25	176,86	174,07	188	120	92	110	28	407	17,13
26 XH 300	2F	St	26	183,93	181,14	198	120	92	110	28	409	18,55
27 XH 300	2F	St	27	191,01	188,22	200	120	92	110	28	410	19,90
28 XH 300	2F	St	28	198,09	195,29	211	150	92	110	28	411	22,27
30 XH 300	2F	St	30	212,23	209,44	226	150	92	110	28	412	25,39
32 XH 300	2F	St	32	226,38	223,59	240	150	92	110	28	414	28,73
34 XH 300	2F	St	34	240,53	237,74	256	150	92	110	28	415	34,20

XH 400

PASSO 7/8" (22,22 mm)

PER CINGHIE LARGHEZZA 4" (101,6 mm)

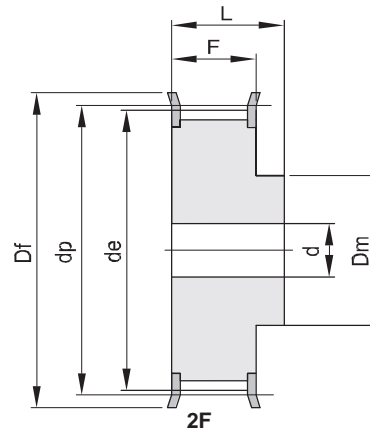

Material: Acciaio (St)

código	tipo	material	denti	dp	de	Df	Dm	F	L	d	n° flangia	Kg.
18 XH 400	2F	St	18	127,34	124,55	138	100	119	132	32	401	9,60
19 XH 400	2F	St	19	134,41	131,62	146	100	119	132	32	402	10,80
20 XH 400	2F	St	20	141,49	138,69	154	100	119	132	32	403	12,87
21 XH 400	2F	St	21	148,56	145,77	160	110	119	132	32	404	14,42
22 XH 400	2F	St	22	155,64	152,84	168	110	119	132	32	405	15,44
24 XH 400	2F	St	24	169,79	166,99	183	120	119	132	32	406	19,22
25 XH 400	2F	St	25	176,86	174,07	188	120	119	132	32	407	21,05
26 XH 400	2F	St	26	183,93	181,14	198	120	119	132	32	409	22,80
27 XH 400	2F	St	27	191,01	188,22	200	120	119	132	32	410	24,66
28 XH 400	2F	St	28	198,09	195,29	211	150	119	132	32	411	27,23
30 XH 400	2F	St	30	212,23	209,44	226	150	119	132	32	412	31,30
32 XH 400	2F	St	32	226,38	223,59	240	150	119	132	32	414	35,20
34 XH 400	2F	St	34	240,53	237,74	256	150	119	132	32	415	40,00